

MasterPatio

Lift-Slider, Slider & Vertical Slider



Penthouse Linkeroever - Antwerp, Belgium
Fabricator: Boven Yvo



Reynaers
Aluminium

Windows.
Doors.
Façades.

Together for better

www.reynaers.com

Clean design, high-performing and futureproof

MasterPatio has been developed to combine clean aesthetics, futureproof design, and best-in-class performance. The versatile system is suitable for passive projects and its consistent look and feel has earned it both a Reddot and Archiproducts design award (2021).

Reynaers Aluminium profiles are already produced with low-carbon energy sources, but with MasterPatio we take your sustainable project to the next level.

Recycled insulation strips and more efficient production methods help us limit the ecological impact of this durable solution.

MasterPatio is more than just a sliding door. It offers multiple opening variants which can be combined effortlessly with our MasterLine 8 and ConceptWall joinery systems. The perfect match to all your project needs.



Private Home - Zandhoven, Belgium
Photo: Stijn Vermeire

The next generation of high-performing sliding systems.

MasterPatio is able to reach passive house U_w thermal levels and offers water tightness of up to 1200 Pa. This makes it the best performing slider & lift-slide system in the market. Thanks to the recycled insulation bars and reduced waste levels during the production process, MasterPatio is your perfect sustainable upgrade.

Clean, consistent and contemporary look for a complete façade solution.

The built-in compatibility with our MasterLine 8 windows and doors and ConceptWall curtain wall systems transforms MasterPatio into a complete floor-to-ceiling façade solution. Build your home or high-rise apartment exactly as you want it to be. Combinations with fixed panels, open corners, and ventilation vents are also possible.

Easy-to-operate and safe system.

As a result of its patented glass support and dedicated hardware, MasterPatio opens and closes effortlessly. Moreover, the aluminium system can be combined with motorisation technology to provide ultimate comfort, even as a Vertical Slider solution. The low and zero threshold variants allow for worry-free accessibility at all times.

MasterPatio General information

Possible vent sizes (mm)

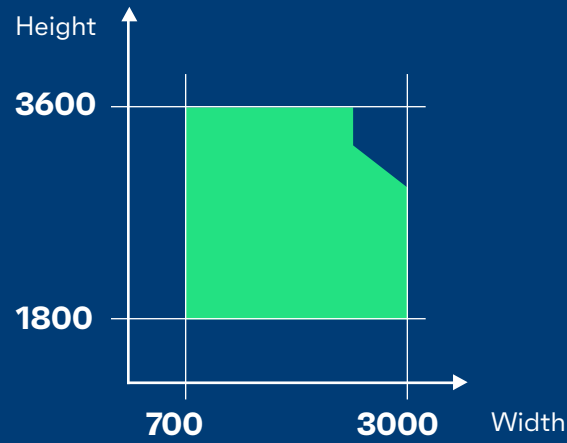

Maximum vent weights (kg)

Slider vent	Lift-slide vent	Fixed vent	Fixed monorail
600 (manual & motorised)	500 (manual) 400 (motorised)	1200	1200

Visible dimensions (mm)

Lift-Slider Monorail Renovation Threshold

1 Vent height	77 or 87
2 Frame height	20
3 Frame depth	180
4 Glass thickness	Up to 62
5 Chicane width	50 or 87

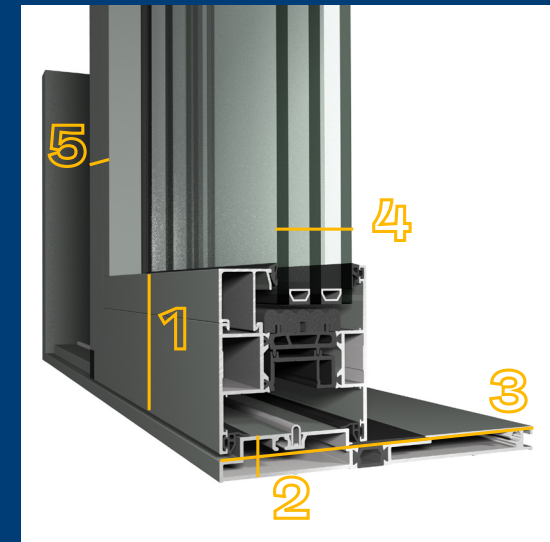

MasterPatio Variants

Lift-Slider 2-rail

Thermal value - Uw (W/m²K)	Down to 0.8
Water tightness	E1050 (1050 Pa)
Wind load resistance	C5 (2000 Pa)
Burglarproof	RC 2 / PAS 24

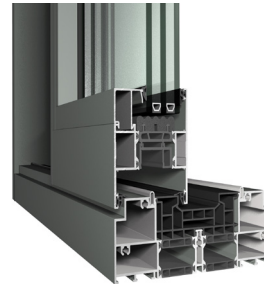

Slider 2-rail

Thermal value - Uw (W/m²K)	Down to 0.8
Water tightness	8A (450 Pa)
Wind load resistance	C5 (2000 Pa)
Burglarproof	RC 2 / PAS 24



Lift-Slider Monorail Outside Glazed

Thermal value - Uw (W/m²K)	Down to 0.8
Water tightness	E1200 (1200 Pa)
Wind load resistance	C5 (2000 Pa)
Burglarproof	RC 2



More variants can be found on our website...

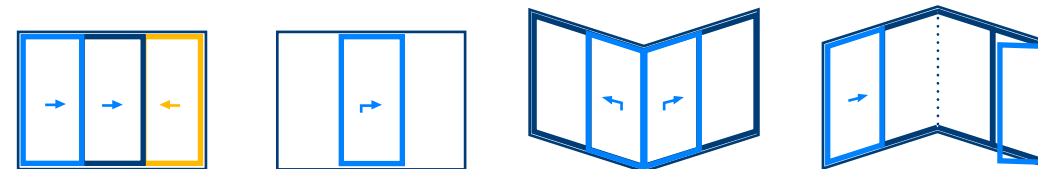

Performance levels, dimensions and properties depend on size, profile combinations, hardware and infill choices. Please contact your Reynaers Aluminium representative for your ideal solution.

MasterPatio Vertical Slider

Opening new opportunities

Discover **MasterPatio Vertical Slider**, one of the latest additions to the Reynaers Aluminium product offer. This unique award-winning system allows for large vents of up to 200kg to open at the push of a button. As a result, you can create a safe balcony feel both in high-end residential and high-rise applications, bringing interior and exterior closer together.

When opened, the Vertical Slider boasts a sleek flush finish, available in one or two fixed vent configurations. Moreover, its convenient ventilation mode helps you let in a fresh breath of air in a safe and comfortable way. Experience this one-of-a-kind motorised variant, a unique solution within our system range.

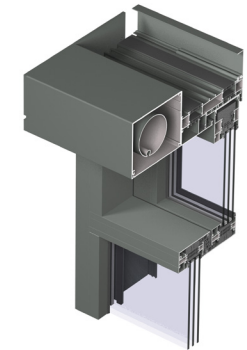

Thermal value - Uw (W/m²K)	Down to 0.8
Air tightness	4 (600 Pa)
Water tightness	E750 (750 Pa)
Wind load resistance	B5 (2000 Pa)
Acoustic performance	43(-1;-3) dB



archiproducts
AWARDS
WINNER

archiproducts
AWARDS
WINNER
SUSTAINABILITY

Possible vent sizes (mm)

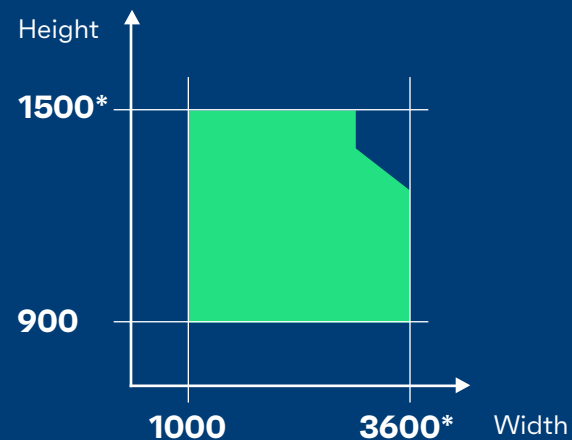

*Max dimensions and weights depend on multiple parameters including wind load requirements and glass type choice.

Maximum vent weights (kg)

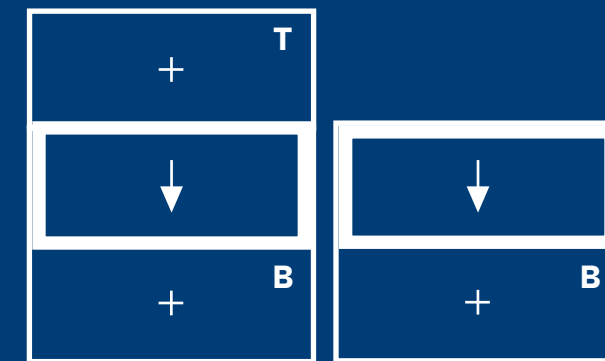

	Max weights
Top Fixed (T)	200
Motorised	200
Bottom Fixed (B)	1200

[Learn more](#)

Do you want to know more about this innovative Vertical Slider solution? Scan the QR code to visit our website, where you will find more product details and data.



MasterPatio Options



Access Control

When it comes to protecting your home or business, you want to have control over who has access to your building, and when. We offer a number of electronic access control systems to protect your residence or business facility.



Gutter

During heavy rain your system might have to process large quantities of water. An integrated gutter can help to guide this flow away from the window, even combined with tiled terrace floors. In most cases we offer aesthetically covered gutter solutions.

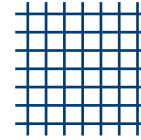

Flyscreen

We offer flyscreens in two variants: traditional & visible, or integrated & concealed flyscreens. Often overlooked at first, it is one of the most popular options amongst our customers.



Motorised

Motors make it easier to operate our products in case you do not want to open them manually. The components are integrated inside the profiles, so it does not impact the overall design.



Private Home - Rotselaar, Belgium
BURO 2018 Architecten
Photo: Yannick Milpas

Sustainability

MasterPatio stands for contemporary design and high performance. The recycled polyamide insulation strips reduce the system's carbon impact and help your home reach comfort levels up to passive house standards. What is more, production waste is reduced thanks to its clever circular design. As a result, this "next generation of sliding doors" is Cradle to Cradle® certified, making it the ideal sustainable upgrade to your project.



Smart Buildings

Our sliding solutions are compatible with the industry's leading smart building systems. With a range of intelligent solutions, our systems do the work for you at the push of a button. No need to worry about keys anymore: the smart system allows you to manage access to your home or building through a fingerprint scanner or mobile app. Moreover, helped by an integrated motor, you can slide even the heaviest panes aside as smoothly as ever.

Get in touch

Interested or looking for more in-depth technical information? Contact your Reynaers Aluminium representative for more information or scan the QR code to visit our website.

